

| | | |
|---|-----------------------------------|-----|
| Ⓓ | Austausch der Kartusche..... | 2/6 |
| Ⓒ | Výměna kartuše..... | 2/6 |
| Ⓓ | Udskiftning af patronen..... | 2/6 |
| Ⓔ | Intercambio del cartucho..... | 2/6 |
| Ⓕ | Remplacement de la cartouche..... | 2/6 |
| Ⓖ | Replacing the cartridge..... | 2/6 |
| Ⓗ | Zamjena kartuše..... | 2/6 |
| Ⓗ | A betét kicserélése..... | 2/6 |
| Ⓘ | Sostituzione delle cartucce..... | 2/6 |
| Ⓝ | Patroonwissel..... | 2/6 |
| Ⓡ | Schimbarea cartușului..... | 2/6 |
| Ⓡ | Замена гильзы..... | 2/6 |
| Ⓢ | Byta patron..... | 2/6 |
| Ⓢ | Zamenjava kartuše..... | 2/6 |
| Ⓢ | Výměna kartuše..... | 2/6 |
| Ⓣ | Kartuşların değiştirilmesi..... | 2/6 |

| | | |
|---|-------------------------------------------------------|-------|
| Ⓓ | Austausch des Ventiloberteils..... | 10/14 |
| Ⓒ | Výměna vrchní části ventilu..... | 10/14 |
| Ⓓ | Udskiftning af ventiloverdelene..... | 10/14 |
| Ⓔ | Sustitución de la parte superior de la válvula..... | 10/14 |
| Ⓕ | Remplacement des clapets céramiques..... | 10/14 |
| Ⓖ | Replacing the upper parts of the valves..... | 10/14 |
| Ⓗ | Zamena gornji ventil..... | 10/14 |
| Ⓗ | Helyettesítés a felső szelepl..... | 10/14 |
| Ⓘ | Sostituzione della parte superiore della valvola..... | 10/14 |
| Ⓝ | Uitwisseling van het ventielbovendeel..... | 10/14 |
| Ⓡ | Schimbarea părții superioare a bateriei..... | 10/14 |
| Ⓡ | Замена верхней части вентиля..... | 10/14 |
| Ⓢ | Byte av ventilöverdelen..... | 10/14 |
| Ⓢ | Zamenjava zgornji ventil..... | 10/14 |
| Ⓢ | Výměna vrchnej části ventilu..... | 10/14 |
| Ⓣ | Valf üst parçasının değiştirilmesi..... | 10/14 |

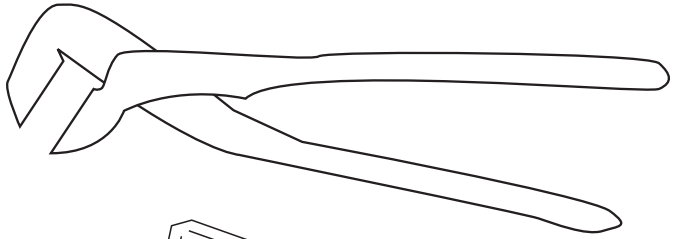

2,5 mm

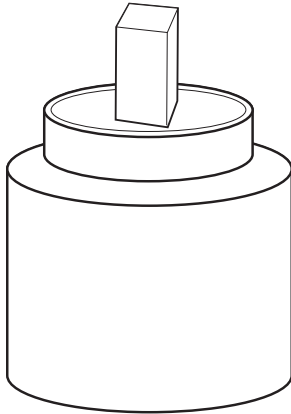
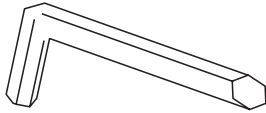

1

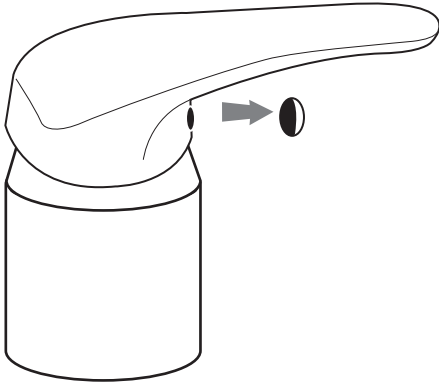

2

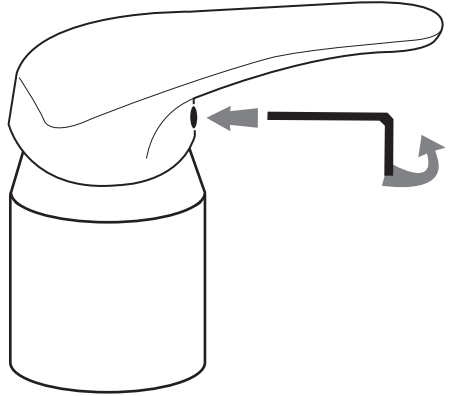

3

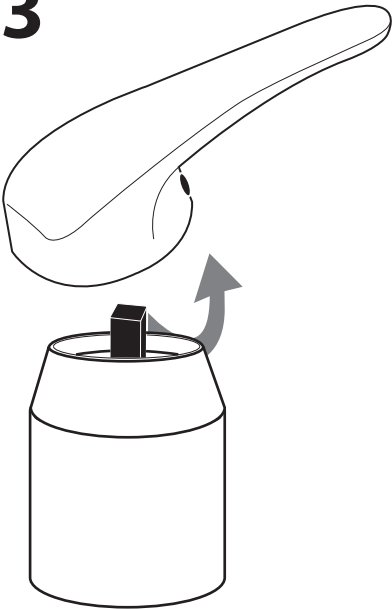

4

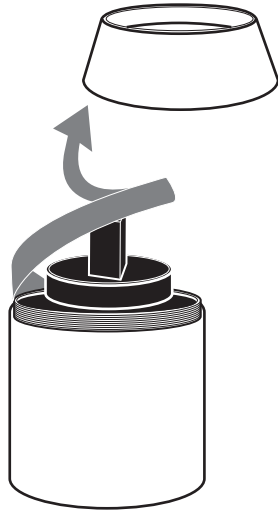

5



6

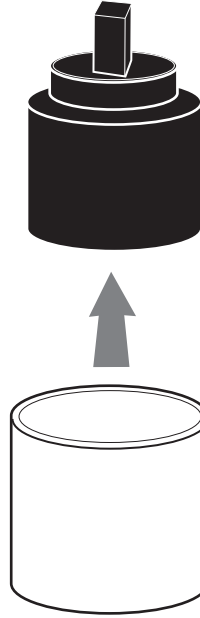

7

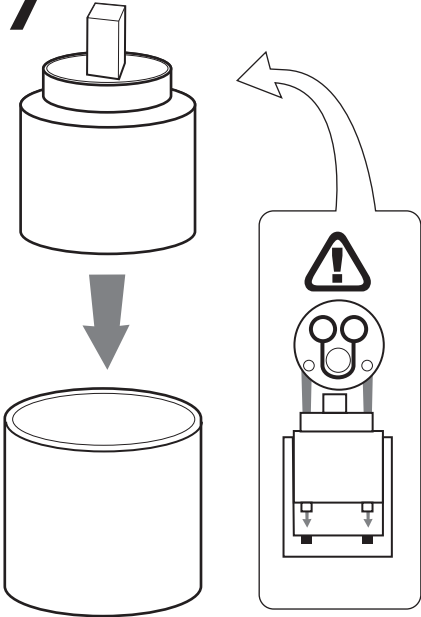

8

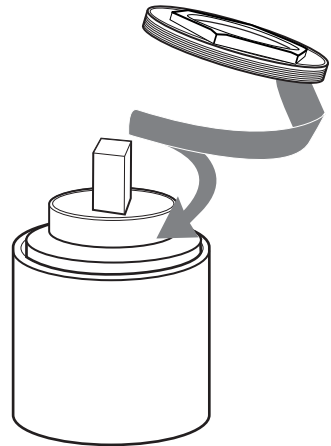

9

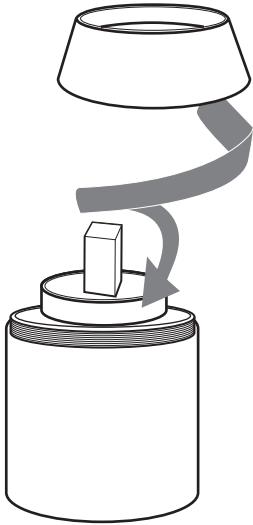

10

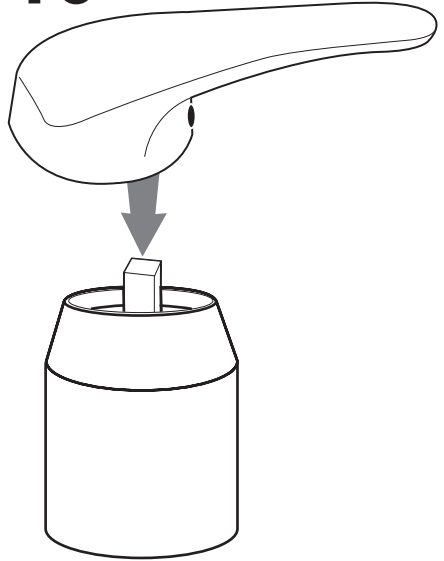

11

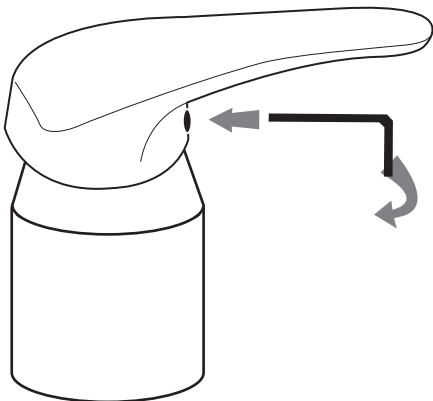

12

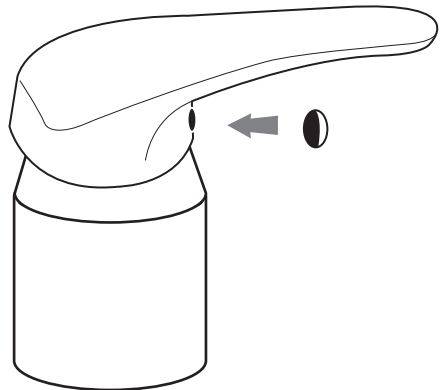

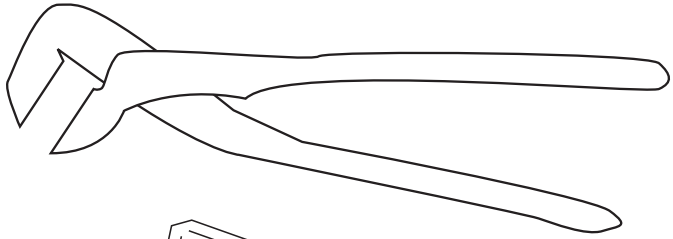

2,5 mm

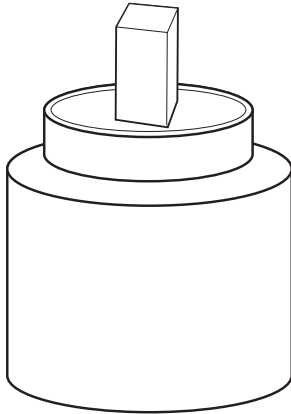
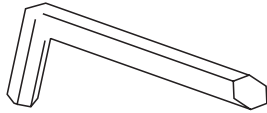

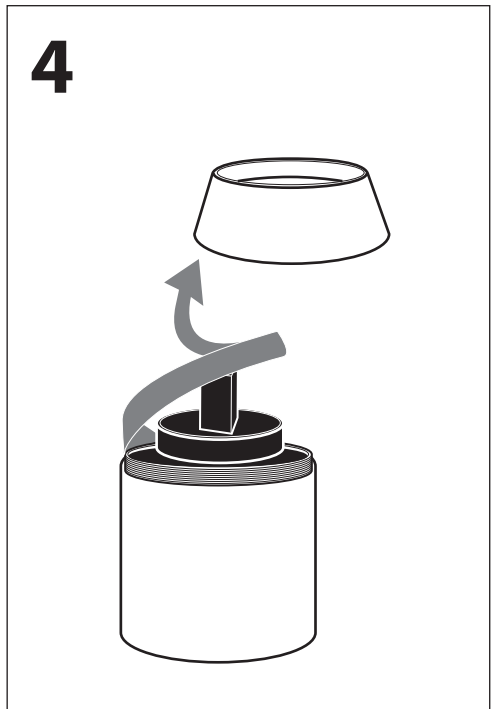
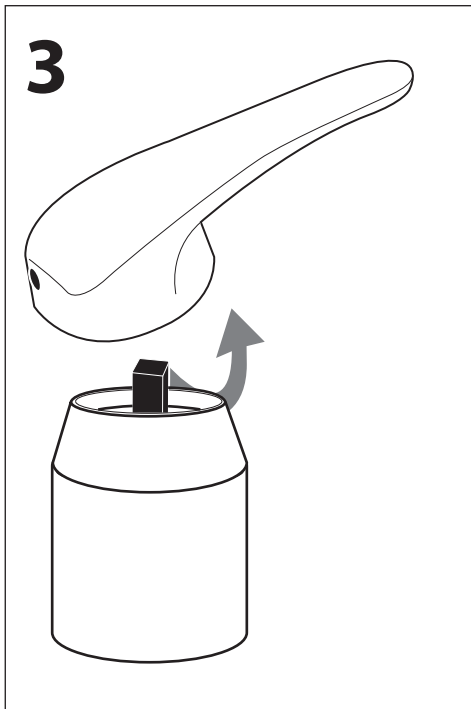
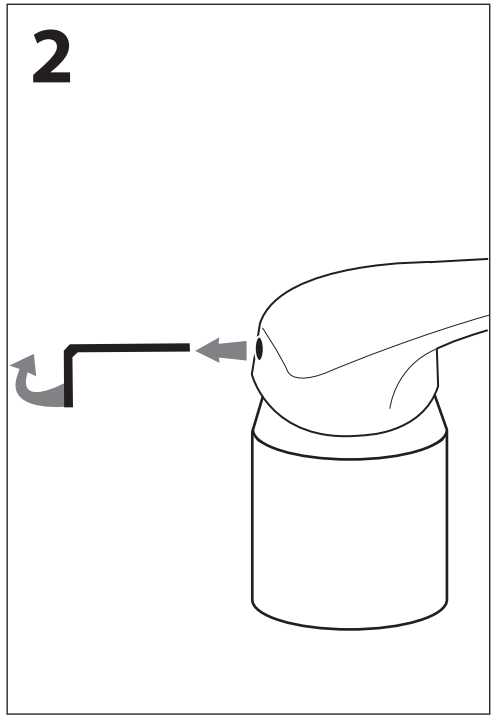
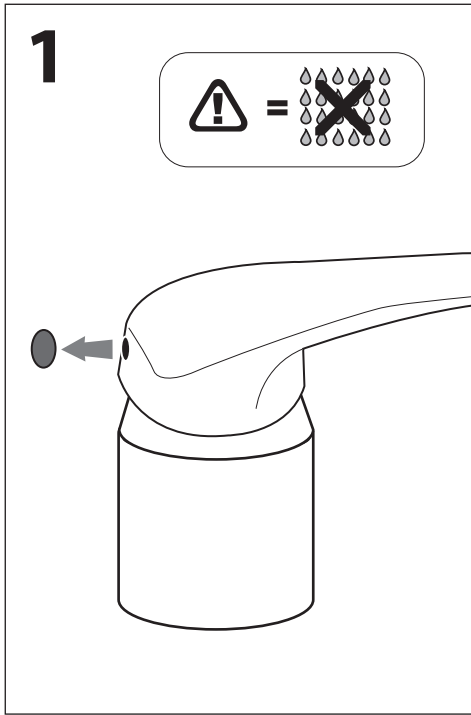

5



6

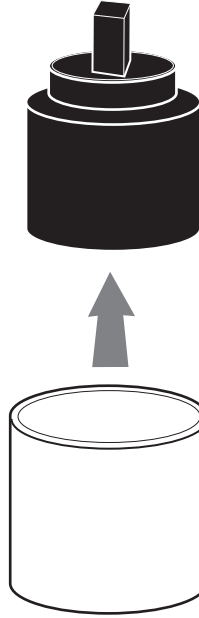

7

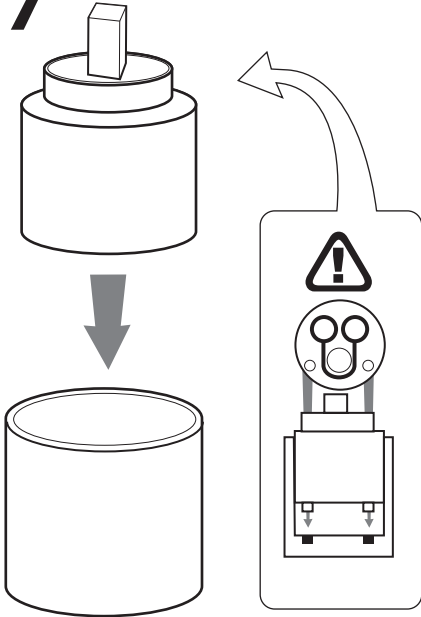

8

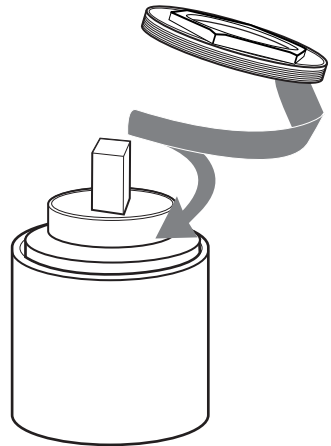

9

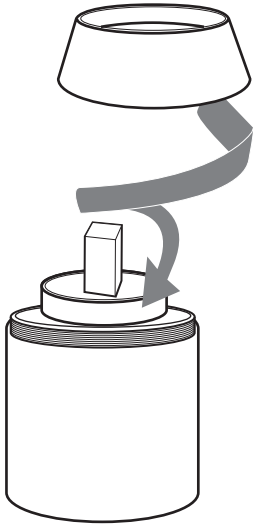

10

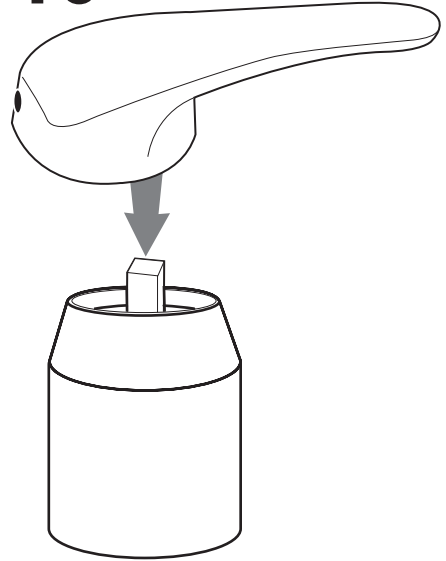

11

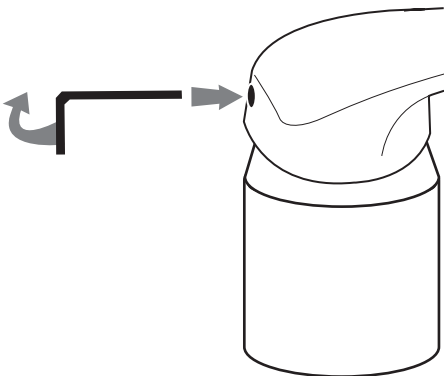

12

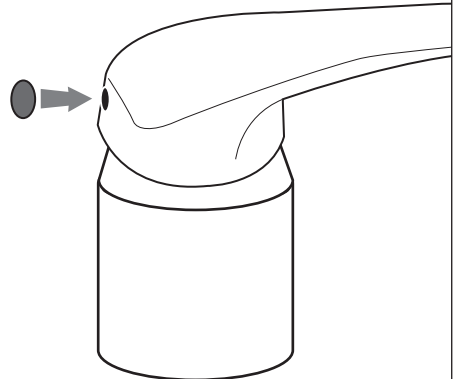

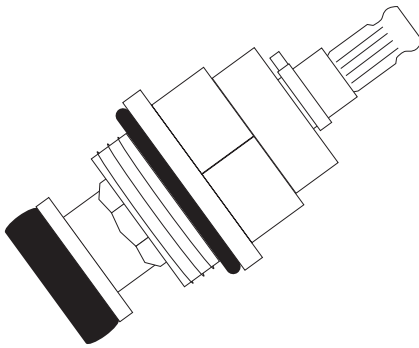
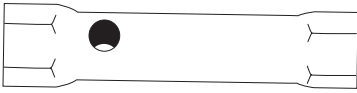
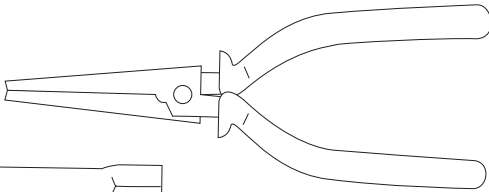

1

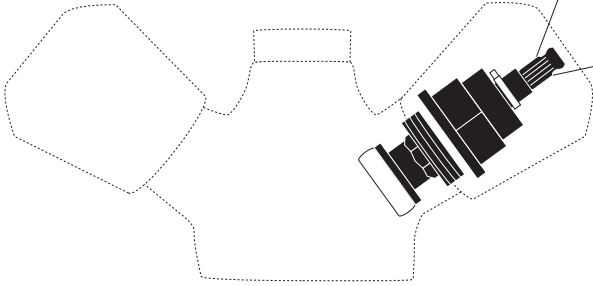
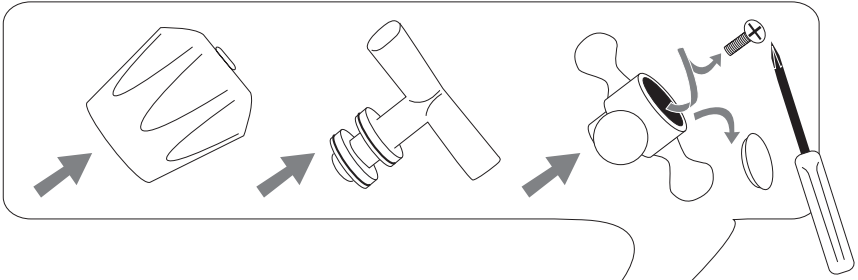

2

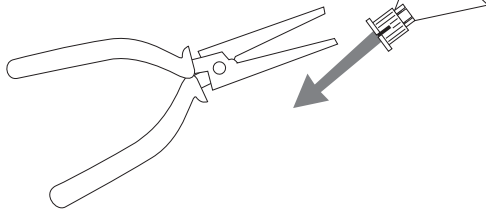
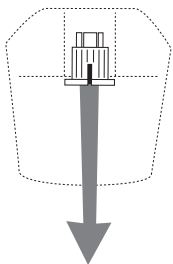
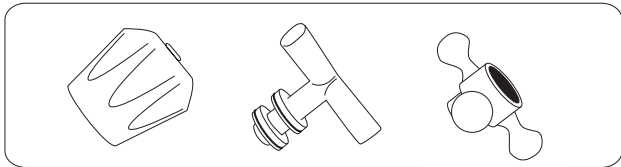

3

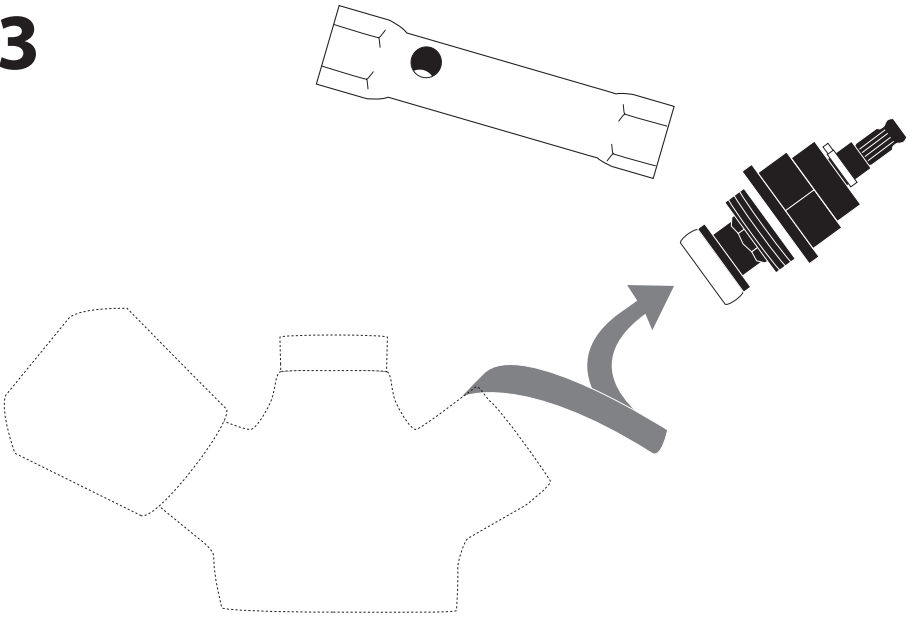

4

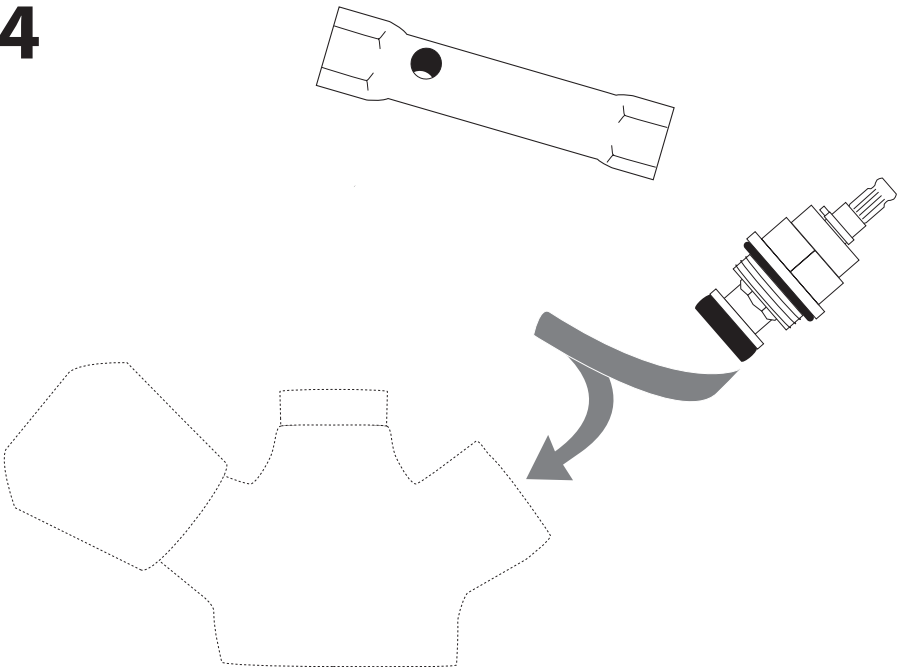

5

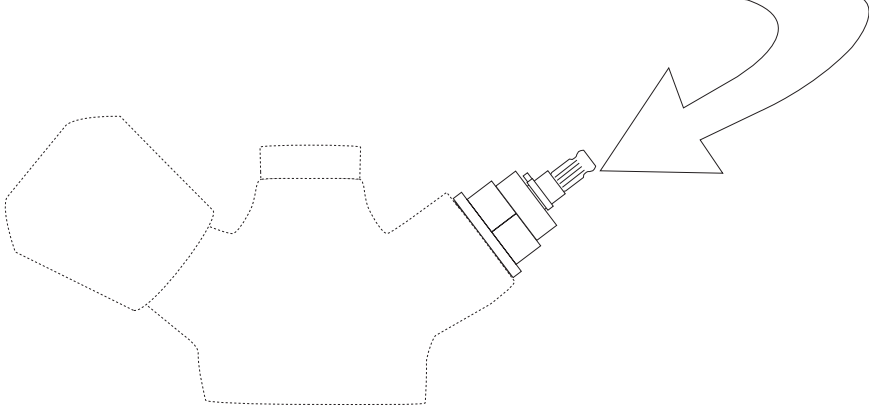
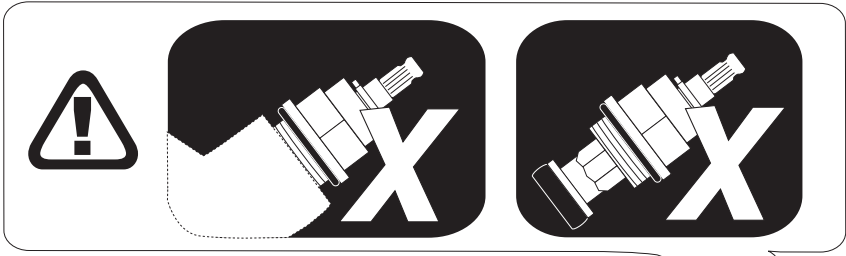

6

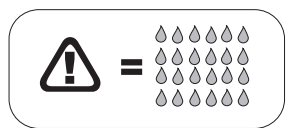
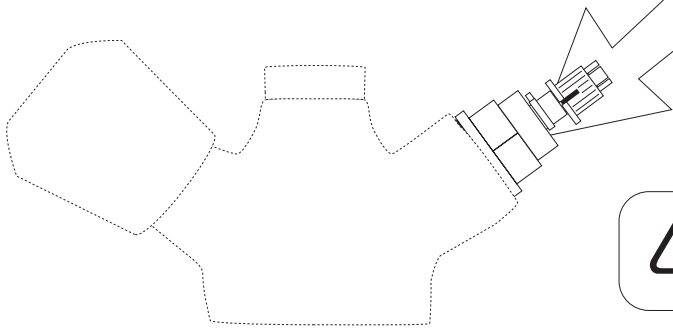
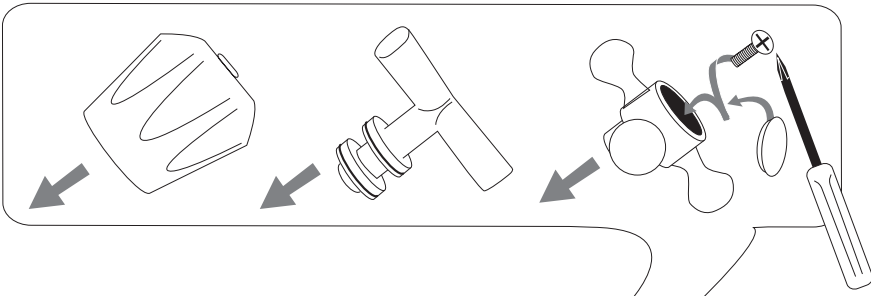

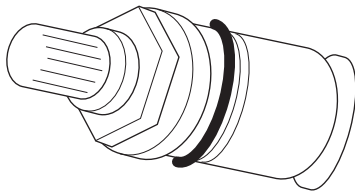
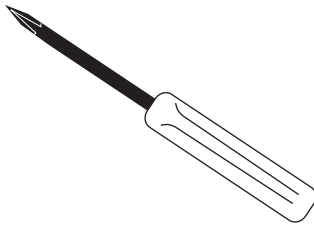

1

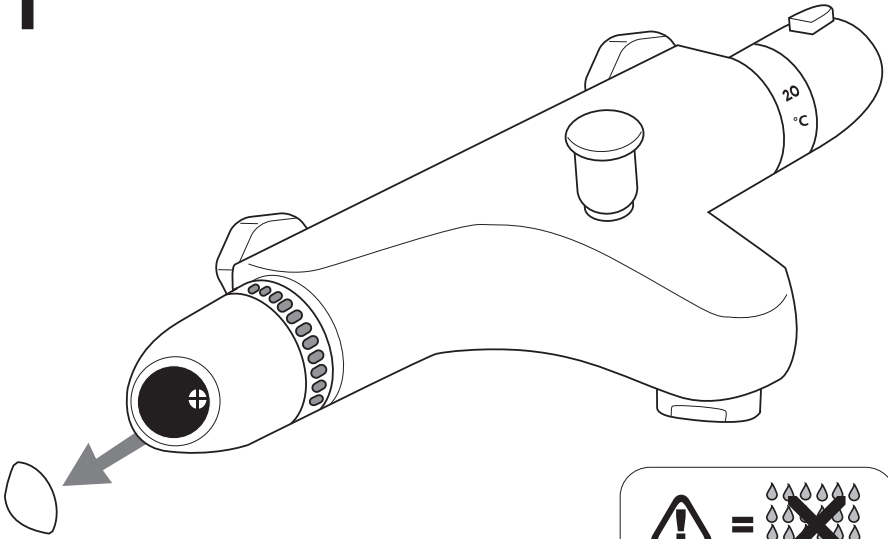

2

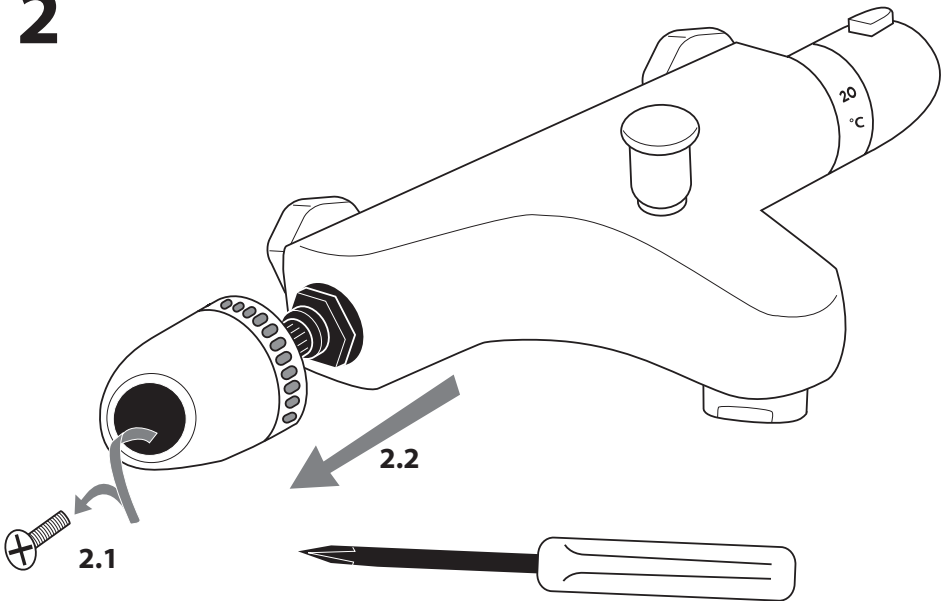

3

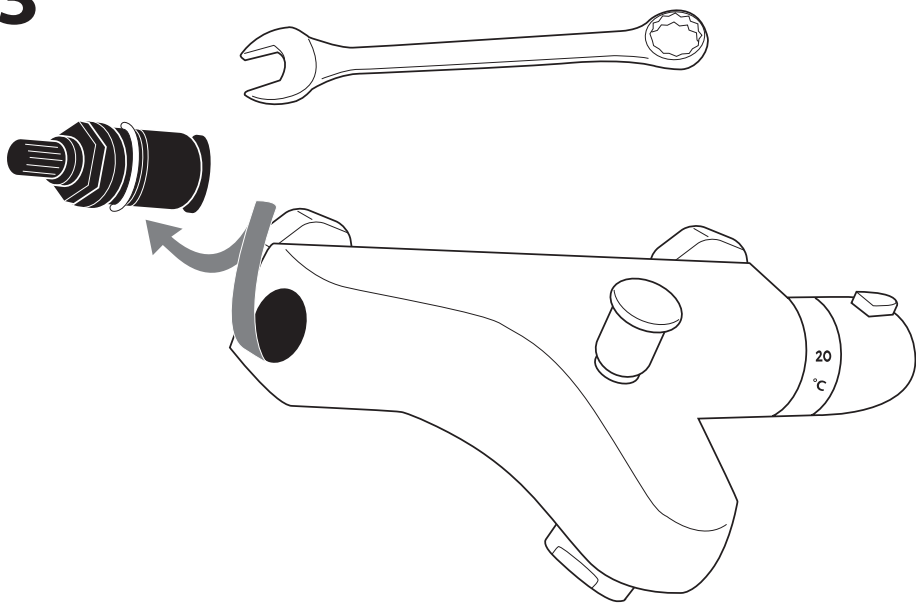

4

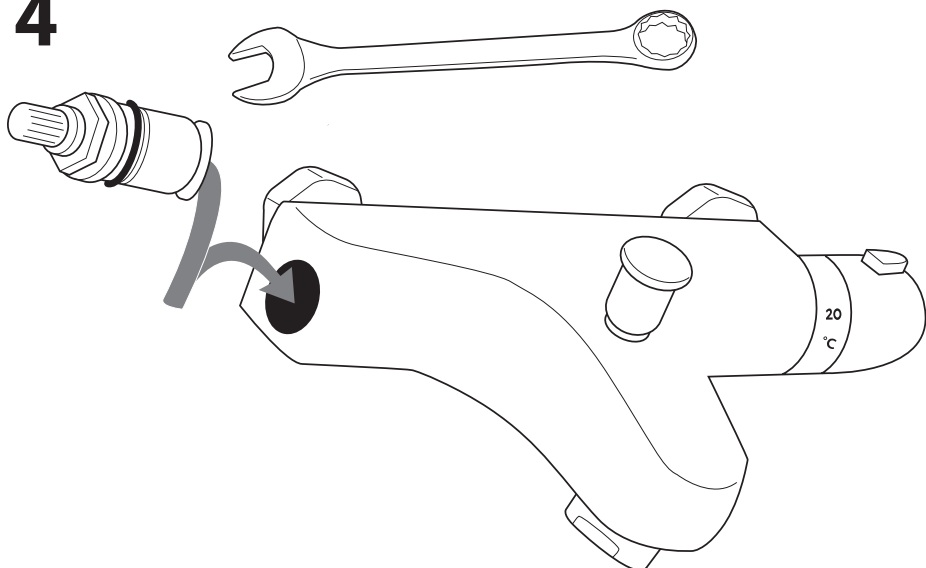

5

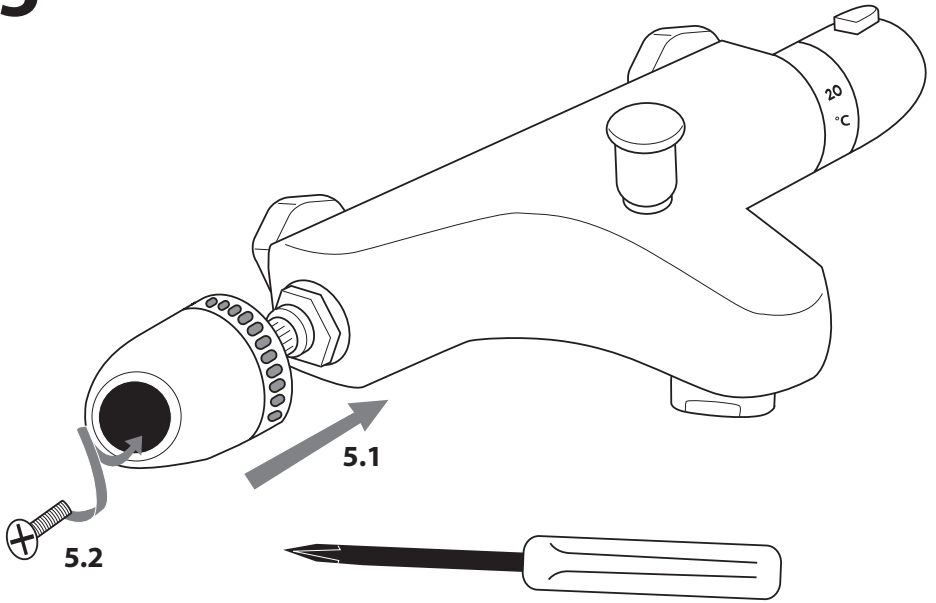

6

